

Rodamiento conico 47896R-47820-JTEKT - 47896R-47820-JTEKT

<https://www.123rodamiento.es/rodamiento-cojinete/rodamiento-rodillos/conico/47896r-47820-jtekt>

Single-row tapered roller bearings
inch series

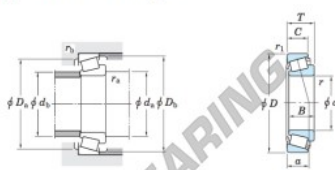

Koyo

Boundary dimensions (mm)							Basic load ratings (kN)		Limiting speeds (min ⁻¹)	
<i>d</i>	<i>D</i>	<i>T</i>	<i>B</i>	<i>C</i>	<i>r_a</i> max.	<i>r_b</i> max.	<i>C_r</i>	<i>C₁₀</i>	Grease lub.	Oil lub.
95.250	146.050	33.338	34.925	28.185	3.6	3.2	178	293	2 500	3 300

Bearing No.		Load center (mm) <i>a</i>	Mounting dimensions (mm)						Constant <i>e</i>	Axial load factors		(Refer.) Mass (kg)	
Inner ring	Outer ring		<i>d_a</i>	<i>d_b</i>	<i>D_a</i>	<i>D_b</i>	<i>r_a</i> max.	<i>r_b</i> max.		<i>Y₁</i>	<i>Y₂</i>	Inner ring	Outer ring
47896R	47820	32.6	110.0	103.0	131.0	140.0	3.6	3.2	0.45	1.34	0.74	1.34	0.657

CARACTERÍSTICAS DEL PRODUCTO

Marca	JTEKT
N° Ean13	3663952429816
Diámetro interior	95.25 mm
Diámetro exterior	146.05 mm
Espesor	33.338 mm
Envasado	1

contacto@123rodamiento.es

911 436 830

CRT4 de Lesquin 60 Rue Du Haut De Sainghin 59273 Fretin FRANCE